

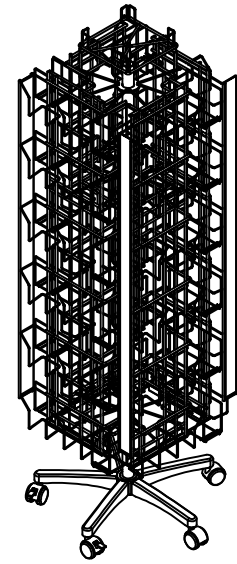

SPECIALTY
STORE SERVICES

Personalized Storybook Spinner Rack Display Assembly Instructions

For additional instructions please visit: Sourcebooks.com/StoreDisplay

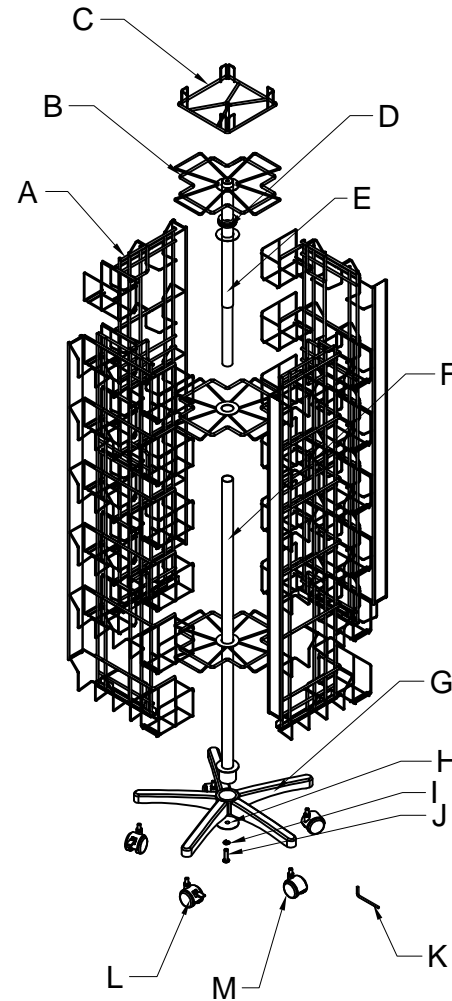
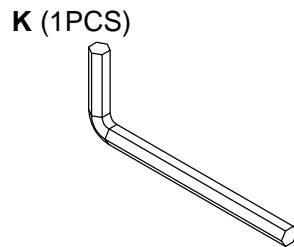
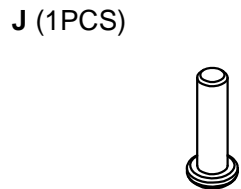
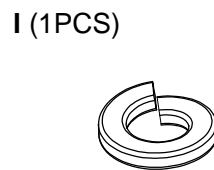
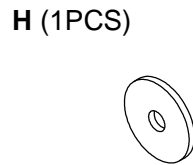
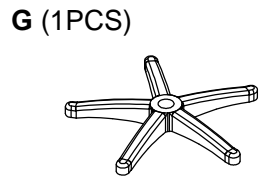
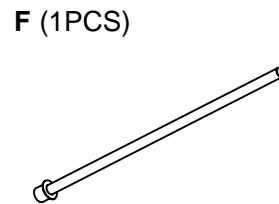
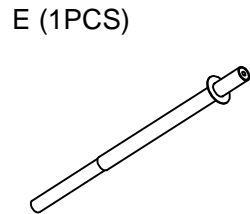
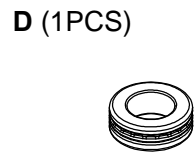
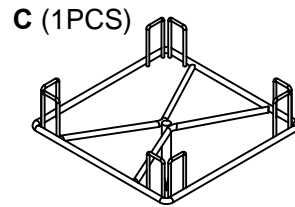
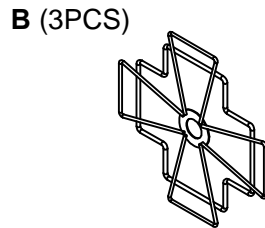
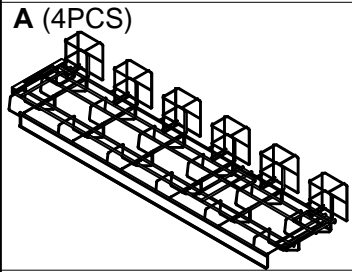



SPECIALTY
STORE SERVICES

Personalized Storybook Spinner Rack Display Assembly Instructions

For additional instructions please visit: Sourcebooks.com/StoreDisplay

1. Install casters **L & M** into the base **G**.

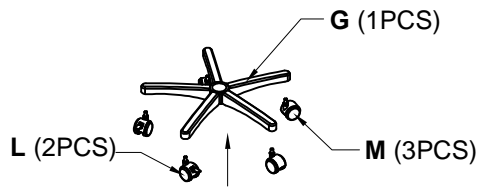

2. Insert upright **F** to the base **G**. Use wrench **K** tighten screw **J** into bottom of the upright **F** with washer **H** & spring washer **I**.

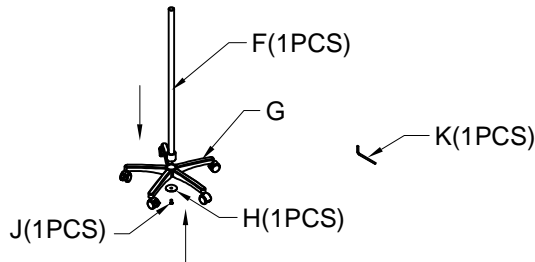

3. Put the 2 pcs wire shelves **B** to the bottom of the upright **F**

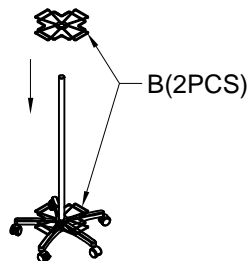

4. Insert the top upright **E** into the upright **F**. Place bearing **D** on the top of the top upright **E**.

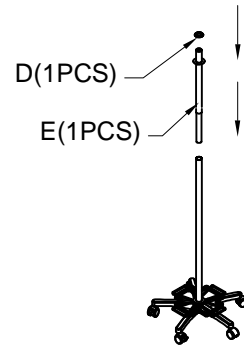

5. Put 1pc wire shelf **B** on the bearing **D**

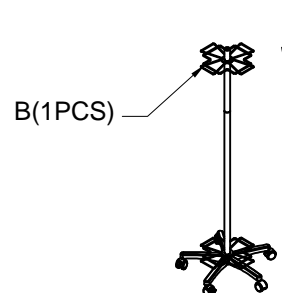

6. Place top hooks on Pocket Panel **A** on the top wire shelf **B**. Continue with 3 other Pocket Panels **A**

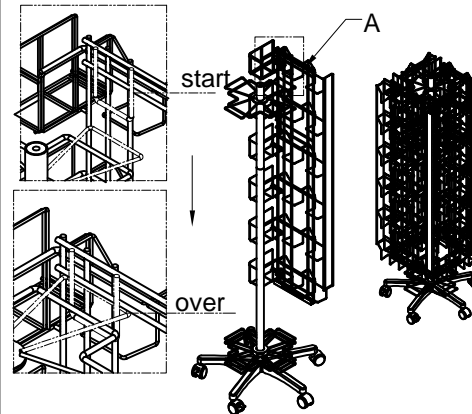

7. Position 1 wire shelf **B** that is resting on the base up upright **F** into the middle the pole. Place the Pocket Panels just past the middle Hanger Bracket and rest it there temporarily

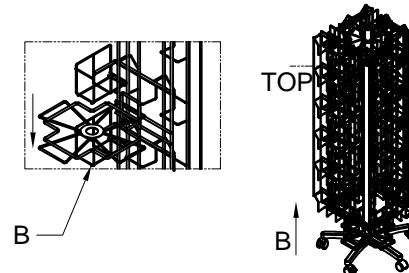

8. Position the last wire shelf **B** resting on the base, up the upright **F** to just above the bottom hooks of pocket panel **A**. Push wire shelves down, snapping them into place.

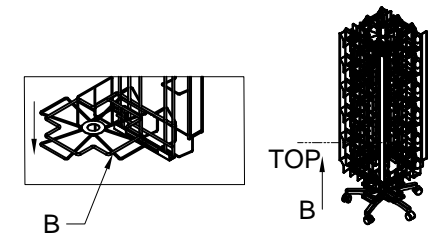

9. Ensure that all 4 wire shelves are connected to each pocket panel

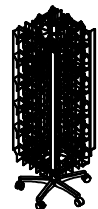

10. Place sign holder **C** in hole on top of the assembled Rack

